

FROG® Leap® Instruction Manual

Mineral Pool-Care Infuzer® for Pools up to 25,000 Gallons



Cleaner

because it kills bacteria two ways

Clearer

because it helps keep pH in range

Softer

because it reduces chlorine use up to 50%*

Easier

with prefilled pacs for no mess,
no guess and no stress



**FROG Leap Infuzer comes with the
FROG Leap Anti-Bac Mineral Pac®
Patented Mineral Disinfectant**

Customer Service 800-222-0169
frogproducts.com



WARNING

To minimize the risk of serious injury, death or damage, before installing or first using this equipment, read Instruction Manual and all safety labels and follow all safety instructions and precautions. Save manual for future reference.

TABLE OF CONTENTS

FROG Leap Introduction	3
Notes and Safety Information	4
Safety Labels on Infuzer	5
Installation Tips to Ensure Proper Performance	6
Sand Filter Installation with Nipple Kit and Flex Hose	7
Sand Filter Installation with Flex Hose Only	8
DE and Cartridge Filter Installation With Flex Hose	9
Hard-Plumbed Installation	10
Step 1: Preparing the Pool	11-12
Step 2: Putting the System to Work	13
Step 3: Setting the Control Dial	14
Step 4: Routine Pool Care	15
Replacing FROG Leap Anti-Bac Mineral Pac	16
Using FROG Leap Pool Wake Up![®]	17
Using FROG Leap All-Out[®]	18
Using FROG Leap Torpedo Pac[®]	19
Winterizing	20
Troubleshooting	21
Parts List	22
Maintenance - Replacing Control Dial O-Rings	23
Maintenance - Replacing Cap O-Rings and Knobs	23
Warranty	24

For information on King Technology's entire product line, visit our website at frogproducts.com

Welcome to easier pool care courtesy of FROG Leap. With FROG Leap, your pool water will look and feel better without a lot of work or a lot of chlorine. This system† controls bacteria using a combination of minerals and reduced chlorine levels. Chlorine lasts 2X longer with the FROG Leap Mineral System.*

There are 4 main parts to the FROG Leap System:

1. FROG Leap Infuzer
2. FROG Leap Anti-Bac Mineral Pac
3. FROG Leap Pool Wake Up!/Pool Hibernation®
4. FROG Leap Torpedo Pac

Part 1
FROG Leap Infuzer

The water treatment center that controls the flow of water to each part of the FROG Leap System.

For Pools up to 25,000 gallons. Part No. 01-01-7820



Part 2
FROG Leap Anti-Bac Mineral Pac

Holds the minerals and fits inside the FROG Leap Infuzer. Part No. 01-12-7822

THE FROG LEAP ANTI-BAC MINERAL PAC MUST BE REPLACED EVERY SIX MONTHS OR AFTER ONE POOL SEASON, WHICHEVER IS SHORTER.



Part 3
FROG Leap Pool Wake Up!/Pool Hibernation

Three-step pool opening and closing kit with an Algae Protection Guarantee. Part No. 01-10-7858.



FROG Leap Reveille®, FROG Leap Depth Charge® and FROG Leap All-Out

Part 4
FROG Leap Torpedo Pac

Prefilled with chlorine tablets and fits inside the FROG Leap Anti-Bac Mineral Pac. Part No. 01-03-7937



FROG Leap Anti-Bac Mineral Pac comes inside the FROG Leap Infuzer and is also sold separately. Also sold separately: FROG Leap Torpedo Pac, FROG Leap All-Out (Part No. 01-10-7872) and FROG Leap Pool Wake Up!/Pool Hibernation.

†FROG Leap Mineral System consists of the FROG Leap minerals silver chloride and carbonate used in conjunction with 0.5 ppm chlorine. The FROG Leap Anti-Bac Mineral Pac must be used in conjunction with the FROG Leap Torpedo Pac, an EPA registered chlorine pool product or a chlorine delivery device.

*Compared to the minimum EPA recommended chlorine level of 1.0 ppm for a stabilized swimming pool.

∞ For pools and hot tubs.

Notes and Safety Information

General Notes

These instructions contain information for the safe and proper operation of this Infuzer. Observe the following principles:

- Ensure that everyone using this Infuzer follows the instructions and safety precautions.
- Keep the instructions nearby and available for reference throughout the service life of this Infuzer.

These instructions do not provide for every possible contingency that might be encountered in connection with installation, operation or maintenance of this equipment. Should further information be desired or should particular issues arise which are not covered sufficiently in this manual, contact King Technology at 800-222-0169.



Explanation of the signal words

Signal words, which depict the probability and severity of harm, are used in these instructions. They are defined as follows:

Signal Word	Meaning
DANGER	Indicates an imminently hazardous situation which, if not avoided, will result in death, serious injury or major property damage.
WARNING	Indicates a hazardous situation which, if not avoided, could result in serious injury, death, or major property damage.
NOTICE	Indicates special instructions that are important but not related to physical injury hazards.

Explanation of the safety pictographs

The following pictographs illustrate the type of hazard.

Pictograph	Type of Danger
	Safety Alert/General Hazard
	Explosion Risk
	Hazardous Pressure
	Flammable Fire Hazard

Identification of warnings

Warnings are intended to help you recognize risks and avoid death, injury or property damage. This is how warnings are identified:

 Signal Word
Pictographs
<p>Description of danger.</p> <p>Consequences if ignored.</p> <p>⇒ The arrow signals a safety precaution to be taken to eliminate or reduce the risk.</p>

Safety Label on Infuzer

Review this label before installing or operating this Infuzer. Contact King Technology at 800-222-0169 if this label is missing from your FROG Leap Infuzer.



Fire, explosion and high pressure hazards

To minimize the risk of serious injury, death or property damage while using the FROG Leap Infuzer:

- ⇒ Read, understand and follow all instructions and safety precautions in the manual, and on this Infuzer and on any label for chemicals used with this Infuzer including FROG Leap Torpedo Pacs, FROG Leap Anti-Bac Mineral Pacs and FROG Leap Pool Wake Up!/Pool Hibernation (which includes FROG Leap Reveille, FROG Leap Depth Charge and FROG Leap All-Out).

DANGER

- ⇒ Never use fast dissolving chlorine tablets, liquid bleach, or calcium hypochlorite in the FROG Leap Infuzer.
- ⇒ Never mix Trichlor chlorine tablets with Calcium Hypochlorite, or with any other form of concentrated chlorine or other chemicals.
- ⇒ Never add any other types of chlorine, pH adjusters, shock treatments or algaecides through the skimmer. These products should be added directly into the pool if required.
- ⇒ Do not contaminate the FROG Leap Infuzer, FROG Leap Anti-Bac Mineral Pac, FROG Leap Torpedo Pac and FROG Leap Pool Wake Up!/Pool Hibernation (which includes FROG Leap Reveille, FROG Leap Depth Charge and FROG Leap All-Out) with dirt, organic matter, pool chemicals (such as calcium hypochlorite or pool shocks), fertilizers or other household chemicals. Contact between any of these substances and the FROG Leap Infuzer including FROG Leap Anti-Bac Mineral Pac, FROG Leap Torpedo Pac, FROG Leap Pool Wake Up!/Pool Hibernation (which includes FROG Leap Reveille, FROG Leap Depth Charge and FROG Leap All-Out) will result in a chemical reaction with the generation of heat, liberation of hazardous gasses and fire or explosion.

WARNING

- ⇒ Use only FROG Leap Torpedo Pacs, FROG Leap Anti-Bac Mineral Pacs, FROG Leap Pool Wake Up!/Pool Hibernation (which includes FROG Leap Reveille, FROG Leap Depth Charge and FROG Leap All-Out) in the FROG Leap Infuzer. Never use bulk chemicals.
- ⇒ To prevent the build up of gas pressure in the FROG Leap Infuzer, be sure the pool return line valves are open – except when opening or servicing the unit.
- ⇒ Do not inhale fumes from the FROG Leap Infuzer or FROG Leap Torpedo Pac.
- ⇒ Avoid sparks, smoking, or any open flame near FROG Leap Infuzer or chemicals.
- ⇒ Do not exceed maximum operating pressure of 50 psi or maximum temperature of 104° F.
- ⇒ Do not remove the cap while under pressure. Always turn off pump and bleed off pressure before opening FROG Leap Infuzer.
- ⇒ Do not install automatic or fast shut off valves downstream of Infuzer.
- ⇒ Always install the FROG Leap Infuzer AFTER a heater (if applicable) on the return line.
- ⇒ Always install any additional sanitizing equipment AFTER and NEVER BEFORE the FROG Leap Infuzer is installed on the return line.
- ⇒ Do not permit children to use or climb on this product. This product must be positioned to prevent children from using it as a means of access to the pool.
- ⇒ Always stand clear of the FROG Leap Infuzer during pump start-up.
- ⇒ Replace FROG Leap Infuzer if you see signs of cracks, damage or degradation to the Infuzer body or cap.

NOTICE

- ⇒ Prior to pressurizing, check with your dealer to ensure your plumbing connections meet building codes.
- ⇒ Failure to properly winterize your FROG Leap Infuzer could result in freeze damage. (See page 20 for winterizing details.)

Installation Tips to Ensure Proper Performance

Before installing, read all directions carefully and contact your dealer for installation support.



WARNING

- Do not exceed maximum operating pressure of 50 psi.
- Do not install automatic or fast shut off valves downstream of feeder.
- Always install the FROG Leap Infuzer AFTER the heater (if applicable) on the return line.
- Always install any additional sanitizing equipment AFTER and NEVER BEFORE the FROG Leap Infuzer is installed on the return line.

1) If using a multi-speed pump, run pump for at least 6 hours per day at high speed (at least 40 gpm).

If the pump will run on low speed 24 hours per day or less than 6 hours per day on high speed, you must bleed the air while the pump is on by unscrewing the back knob until water appears. Then screw the knob back in. Repeat this process each time the cap is removed for any reason.



2) Install system with 4-8 psi back pressure.

Lower back pressures could result in under chlorination. Change the eyeball fittings in the return jets to a smaller size to increase back pressure. Contact King Technology at 800-222-0169 for a specially designed Infuzer pressure gauge to determine back pressure at pool start-up.



Part No. 01-22-4000

3) Special installation Requirements:

IMPORTANT: Over chlorination or damage to the FROG Leap Infuzer or other equipment could result if special installations A, B or C are not used in these situations.

- If water flow is higher than 80 gallons per minute (gpm), see diagram A.
- If an in-floor cleaner is included with pool, see diagram B, with two options. Preferred installation is Option 1 with two separate lines.
- If set-up is a pool and spa combination with common equipment, see diagram C.

Questions? Call Customer Service at 800-222-0169 Monday thru Friday, 8 am to 5 pm central time.

A. With High Flow Rate (greater than 80 gpm)

Install T-fittings exactly as shown.

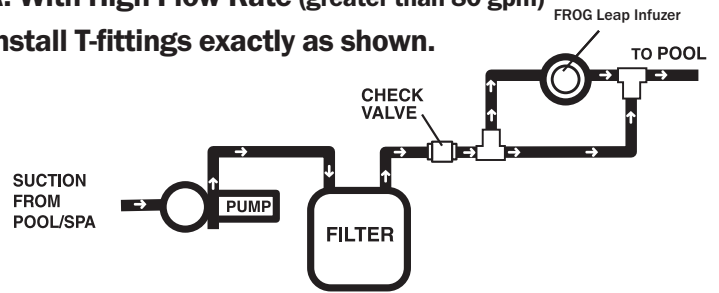

B. With In-Floor Cleaner - TWO OPTIONS

OPTION 1 - A Two-Line Installation

The best option is to have two lines. One line with pump, filter, heater and FROG Leap Infuzer and a second line with a separate pump for the in-floor cleaning system (filter optional).

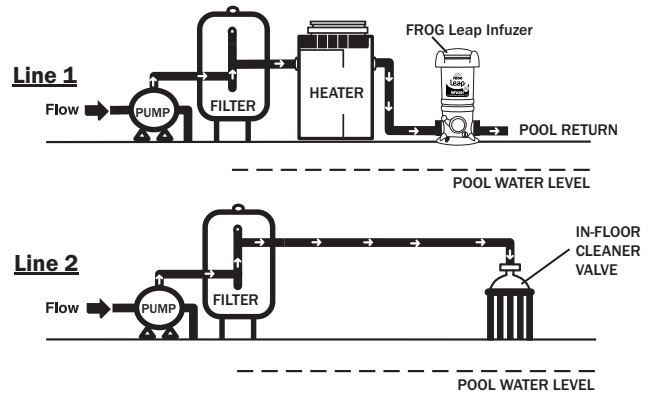

OPTION 2 - A 3-Way Valve Installation

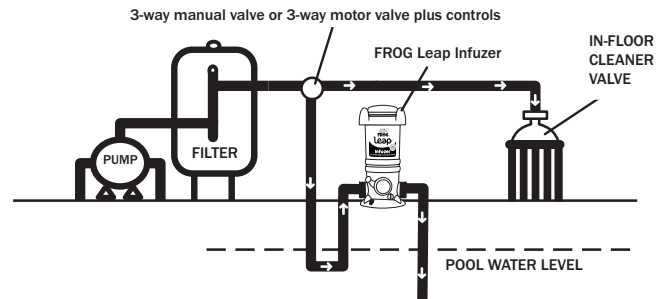

C. Pool and Spillover Spa Combination

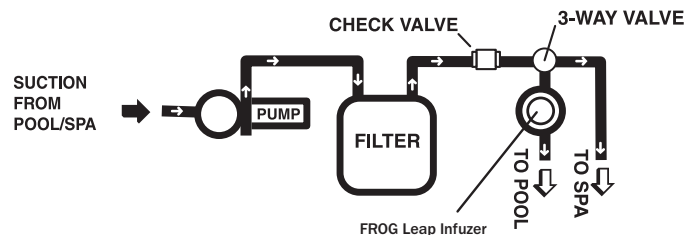

TOOLS NEEDED

Screwdriver



Pipe Wrench

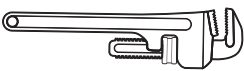

INCLUDED WITH FROG Leap Infuzer

Pipe Thread Tape or Sealant



One 6" X 1 1/2" TBE PVC Nipple



MATERIALS NEEDED

One Hose Adapter
1 1/2" X 1 1/2" X 1 1/4"

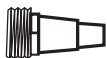

One Section of
1 1/2 or 1 1/4" Flex Hose

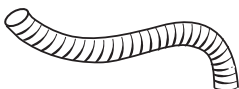

One
Hose Clamp



RECOMMENDED

4-8 psi Back Pressure

To avoid over or under chlorination, replace eyeball fittings in the return jets to a smaller or larger size to adjust back pressure. For best results use King Technology's pressure gauge, order Part No. 01-22-4000.



Sand Filter Installation with Nipple Kit and Flex Hose

1. Apply pipe thread tape or sealant to each threaded end of nipple.

2. Screw one end of nipple into the filter return. Hand tighten. Finish tightening by turning 1 to 2 revolutions with a pipe wrench. **DO NOT OVER TIGHTEN.**

3. Screw either side of FROG Leap Infuzer on to open nipple end until upright and secure.

4. Apply pipe thread tape or sealant to threaded end of hose adapter.

5. Screw adapter into the other side of FROG Leap Infuzer. Hand tighten. Finish tightening by turning 1 to 2 revolutions with a pipe wrench. **DO NOT OVER TIGHTEN.**

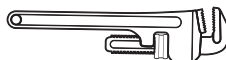

6. Attach return section of hose to the adapter with clamp. Tighten clamp with screwdriver.

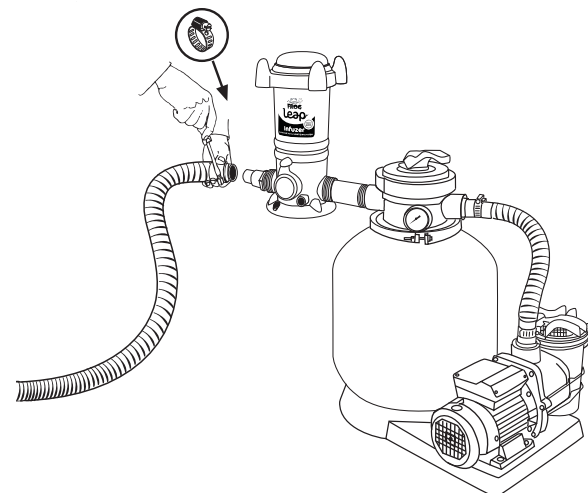

7. To prevent damage to heaters or filters, see your dealer about installing a **corrosion resistant check valve** which will reduce the back flow of chlorine gas when the Infuzer is turned off.

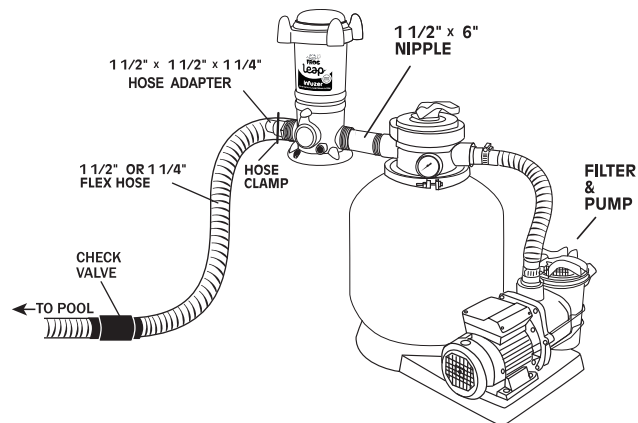

TOOLS NEEDED

Screwdriver

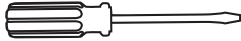

Pipe Wrench

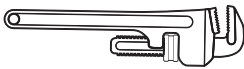

MATERIALS NEEDED

Pipe Thread
Tape
or Sealant

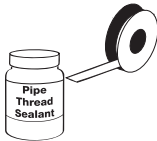

Two Hose Adapters
1 1/2" X 1 1/2" X 1 1/4"



Two Sections of 1 1/2"
or 1 1/4" Flex Hose

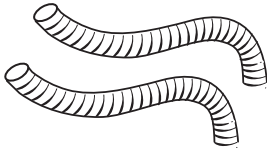

Two
Hose
Clamps



RECOMMENDED

4-8 psi Back Pressure

To avoid over or under chlorination, replace eyeball fittings in the return jets to a smaller or larger size to adjust back pressure. For best results use King Technology's pressure gauge, order Part No. 01-22-4000.



Sand Filter Installation with Flex Hose Only

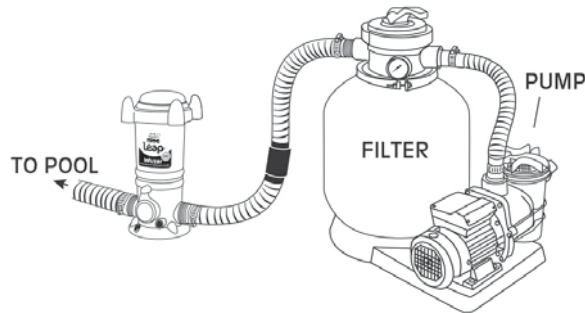

The FROG Leap Infuzer should always be installed between the filter and pool (or between heater and pool if applicable). Never install FROG Leap Infuzer before the heater or damage to the heater could occur.



1. Apply pipe thread tape or sealant to the threaded end of both hose adapters.

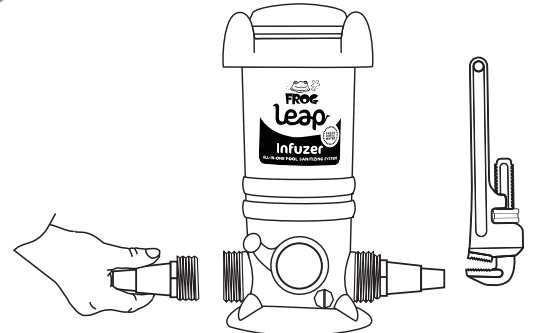

2. Screw adapters into each end of FROG Leap Infuzer. Hand tighten. Finish tightening by turning 1 to 2 revolutions with a pipe wrench. **DO NOT OVER TIGHTEN.**

3. Attach the filter section of flex hose to one hose adapter and the return section of flex hose to the other hose adapter with clamps and tighten with screwdriver. Bi-flow valve design allows water flow in either direction.

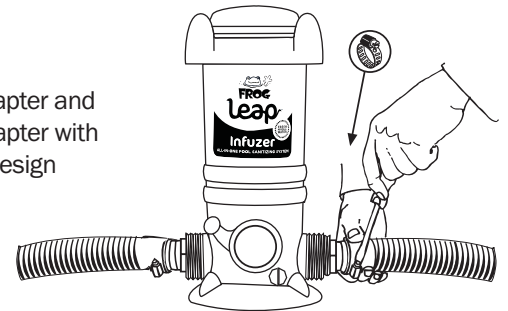

4. To prevent damage to heaters or filters, see your dealer about installing a **corrosion resistant check valve** which will reduce the back flow of chlorine gas when the Infuzer is turned off.

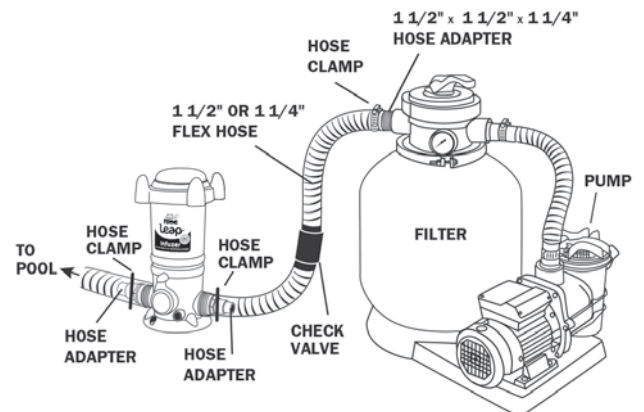

5. For better stability, FROG Leap Infuzer may be mounted on a treated wood base using **Phillips pan head screws**, one in front and two in back. If you have questions about stability, please contact your dealer or King Technology.

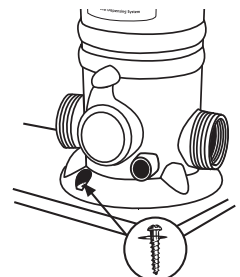

TOOLS NEEDED

Screwdriver

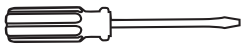

Pipe Wrench

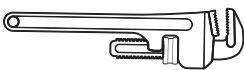

MATERIALS NEEDED

Pipe Thread Tape or Sealant

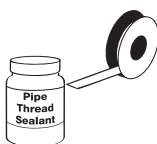

Two Hose Adapters
1 1/2" X 1 1/2" X 1 1/4"



Two Sections of 1 1/2" or 1 1/4" Flex Hose

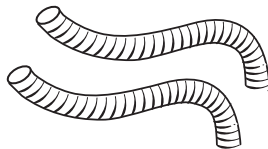

Two Hose Clamps



RECOMMENDED

4-8 psi Back Pressure

To avoid over or under chlorination, replace eyeball fittings in the return jets to a smaller or larger size to adjust back pressure. For best results use King Technology's pressure gauge, order Part No. 01-22-4000.



DE and Cartridge Filter Installation With Flex Hose

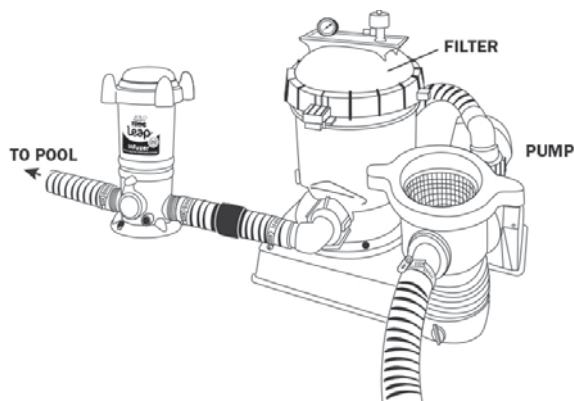

The FROG Leap Infuzer should always be installed between the filter and pool (or between heater and pool if applicable). Never install FROG Leap Infuzer before the heater or damage to the heater could occur.



1. Apply pipe thread tape or sealant to the threaded end of both hose adapters.

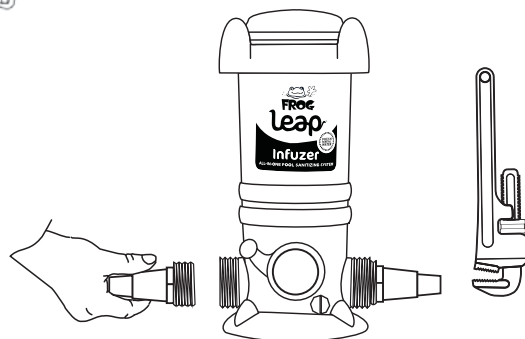

2. Screw adapters into each end of FROG Leap Infuzer. Hand tighten. Finish tightening by turning 1 to 2 revolutions with a pipe wrench. **DO NOT OVER TIGHTEN.**

3. Attach the filter section of flex hose to one hose adapter and the return section of flex hose to the other hose adapter with clamps and tighten with screwdriver. Bi-flow valve design allows water flow in either direction.

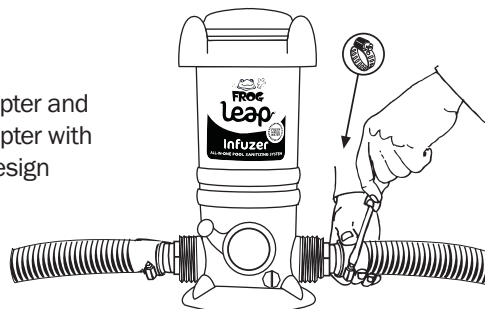

4. To prevent damage to heaters or filters, see your dealer about installing a **corrosion resistant check valve** which will reduce the back flow of chlorine gas when the Infuzer is turned off.

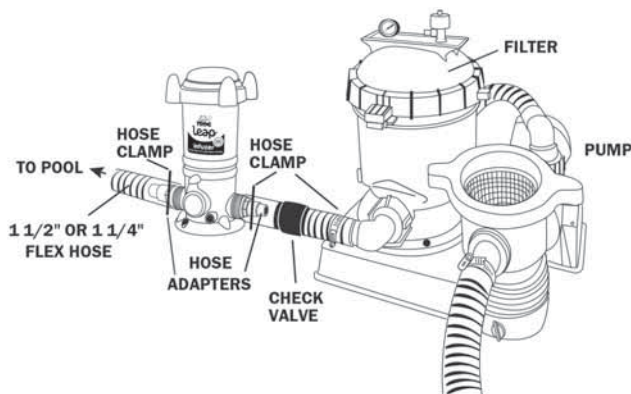

5. For better stability, FROG Leap Infuzer may be mounted on a treated wood base using **Phillips pan head screws**, one in front and two in back. If you have questions about stability, please contact your dealer or King Technology.

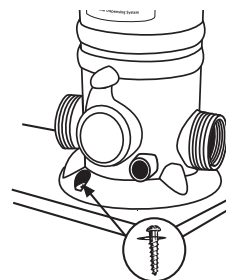

TOOLS NEEDED

Pipe Wrench

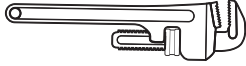

Hacksaw

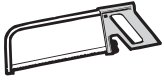

Tape Measure

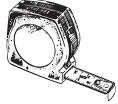

MATERIALS NEEDED

Pipe Thread Tape or Sealant, Primer and PVC Cement

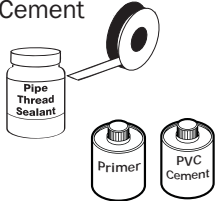

1½" Male Adapter (slip x MPT)



or

2" Female Adapter (slip x FPT)



SECURE INFUZER

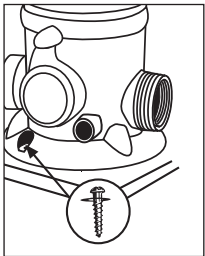

For better stability, FROG Leap Infuzer may be mounted on a treated wood base using **Phillips pan head screws**, one in front and two in back. If you have questions about stability, please contact your dealer or King Technology.

Hard-Plumbed Installation

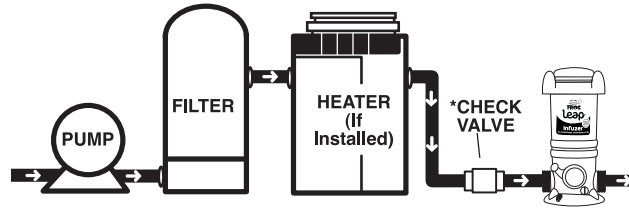

The FROG Leap Infuzer should always be installed between the filter and pool (or between heater and pool if applicable). Never install FROG Leap Infuzer before the heater or damage to the heater could occur.

Do NOT install in copper pipe if using FROG Leap Torpedo Pac as chemical corrosion may lead to pipe failure.



Do NOT install FROG Leap Infuzer off-line.

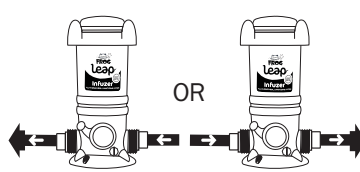

Bi-flow valve design allows installation in either flow direction.

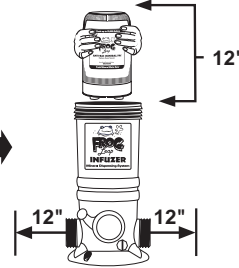

Allow a minimum of 12" above and on each side of FROG Leap Infuzer to ensure room for easy replacement of FROG Leap Anti-Bac Mineral Pac and FROG Leap Torpedo Pac.

1. Screw adapters into each end of FROG Leap Infuzer following directions for a male adapter or a female adapter. Hand tighten. Finish tightening by turning 1 to 2 revolutions with a pipe wrench. **DO NOT OVER TIGHTEN.**

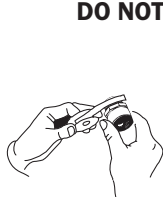

1a.

If using **male adapters**, apply pipe thread tape or sealant to the threaded end of each adapter.

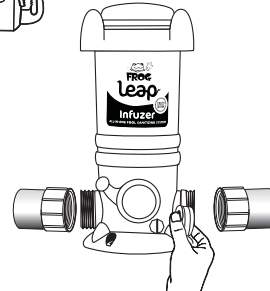

1b.

If using **female adapters**, apply pipe thread tape or sealant to the threaded end of each feeder port.

2. Measure the distance between the outside adapters and cut out a section of pipe 3" less than that dimension.

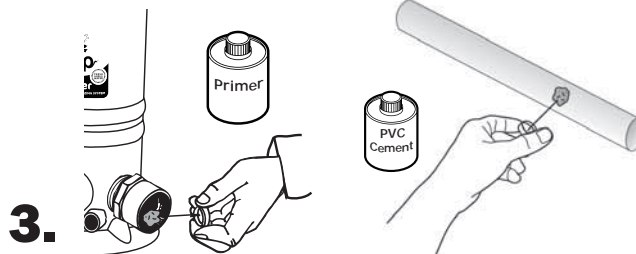

3.

Following Primer directions, brush Primer on the inside of the adapters and to ends of pipe. Repeat this process with PVC cement following manufacturer's directions on that product.

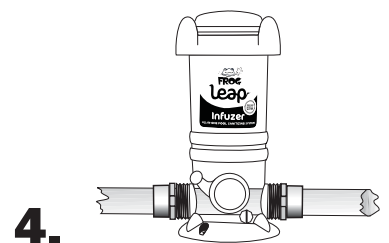

4.

Insert PVC pipe into adapters with a twisting action. Hold in place 5 to 10 seconds to bond.

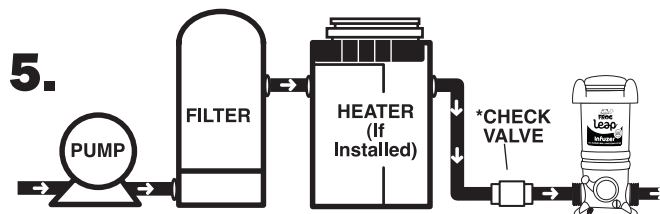

5.

To prevent damage to heaters or filters, see your dealer about installing a **corrosion resistant check valve** which will reduce the back flow of chlorine gas when the Infuzer is turned off.

Step 1: Preparing the Pool



1. Make sure the pool has adequate circulation. The total volume of pool water must completely circulate through the pump and filter at least 1 to 2 times per day. This usually requires 8 to 12 hours of circulation. Check with your dealer for the proper circulation time for your pool.

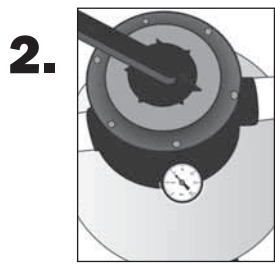

2. Check the pool's filter gauge often and periodically clean filter per the manufacturer's directions. A dirty filter will slow the flow of water which could hamper proper circulation.



WARNING

Do not exceed maximum operating pressure of 50 psi.

3. Check the Water Hardness of your fill water before adding to the pool. If calcium content is higher than 400 ppm find a soft water source to fill your pool instead; otherwise water balance will be very difficult.

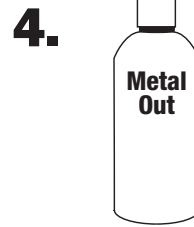

4. Check for metals in the pool such as iron or copper. Before attempting water balance these should be removed. See your dealer for a metal out or sequesterant and follow the label directions carefully.

5. Before beginning with any pool care program, you must first balance your pool water. Take a water sample to your local pool professional (or use a complete test kit) to test for the important Water Balance Guidelines.

IMPORTANT: Always follow printed instructions on the balancing chemical packages. Add balancing chemicals in small increments, one at a time, with circulation running. **For best results, wait 8-12 hours** before testing again and adding any additional balancing chemicals.

Water Balance Guidelines

pH:	7.2 - 7.8
Total Alkalinity:	80 - 120 ppm
Hardness:	200 - 400
Total Dissolved Solids:	<1500
Stabilizer:	20 - 80 ppm
Free Chlorine:	0.5 - 1.0 ppm

Continue... Step 1: Preparing the Pool

For best results in achieving water balance, follow steps **5a through 5e** in order.

5a. Take a water sample from the pool and dip a FROG Test Strip into it.



5b. Look at the **Total Alkalinity** reading first. Adjustments should be made to bring the Total Alkalinity in the range of **80 – 120 ppm** prior to making any adjustments to pH even if it throws pH off further.

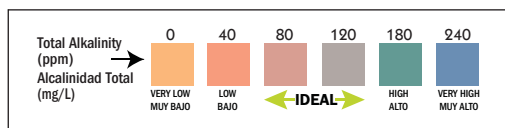

5c. After Total Alkalinity is in range, test for **pH**. It should be between **7.2 and 7.8**. If higher or lower, add a pH adjuster.

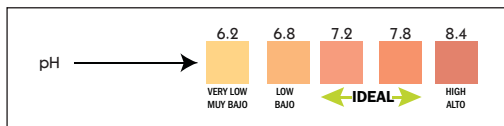

5d. Then test your Water Hardness again. If lower than 200 ppm, add Calcium Increaser. Always maintain 200-400 ppm.

5e. Lastly, test for **stabilizer** or **conditioner levels**. Add conditioner if the level is below 20 ppm. This will prevent chlorine burn off. If stabilizer level is above 80 ppm, partially drain water and re-fill.

6. Initially shock the pool with a **chlorine shock only** to rid the water of contaminants and establish a chlorine residual. Always follow the manufacturer's directions carefully. See the DANGER box below for important guidance on shocking.



DANGER

- Never add any other types of chlorine, pH adjusters, shock treatments or algaecides through the skimmer. These products should be added directly into the pool if required.
- Never use fast dissolving chlorine tablets, liquid bleach, or calcium hypochlorite in the FROG Leap Infuser.

Step 2: Putting the System to Work

1.



Install a FROG Leap Anti-Bac Mineral Pac into the FROG Leap Infuzer. (See page 16 for directions.)

IMPORTANT:

Replace the FROG Leap Anti-Bac Mineral Pac every 6 months or after one pool season, whichever is shorter. After that time, you will hear the spent media inside, however it is no longer effective and must be replaced.

2.



Replace cap and run FROG Leap Infuzer, with FROG Leap Anti-Bac Mineral Pac inserted, for 10 minutes on Setting 10.

3.



Shock the pool with FROG Leap Depth Charge to rid the water of contaminants. (See page 17 for FROG Leap Depth Charge directions.)

4.



Create a chlorine residual with FROG Leap Reveille. (See page 17 for FROG Leap Reveille directions.)



DANGER

If using standard chlorine shocks do not add in or near the skimmer or into the FROG Leap Infuzer as it could damage equipment, risk potential explosion or discolor your pool surface.

5.



Insert FROG Leap All-Out into the open center of the FROG Leap Anti-Bac Mineral Pac in the Infuzer. (See page 18 for directions.)

Use FROG Leap All-Out for a 90-day Algae Protection Guarantee!

6.



When chlorine reading is down to 1.0 ppm, which may take a few days, insert FROG Leap Torpedo Pac into the open center of the FROG Leap Anti-Bac Mineral Pac. (See page 19 for directions.)

Step 3: Setting the Control Dial

1. This system is designed to work effectively with a variety of pool equipment as long as the following procedures are followed.

Set the control dial by matching up the parameters of your pool on the chart below. THIS IS A STARTING POINT ONLY and may need to be adjusted to fit your individual pool needs. See #2 below for adjusting directions. **IMPORTANT:** If using a multi-speed pump, pump-run times of at least 6 hours per day at high speed are recommended for proper performance.

If running the pump at low speed only or on high speed less than 6 hours per day, please follow the 24 hour low-speed directions below.

POOL SIZE		8 HOUR PUMP RUN TIME				12 HOUR PUMP RUN TIME				24 HOUR PUMP RUN TIME			
Gallons	Diameter	PUMP SIZE				PUMP SIZE				PUMP SIZE			
		1/2 hp	3/4 hp	1 hp	1 1/2 hp	1/2 hp	3/4 hp	1 hp	1 1/2 hp	1/2 hp	3/4 hp	1 hp	1 1/2 hp
7,000	(18')	5.0	4.5	4.0	3.5	4.5	4.0	3.0	5.0^	3.5	3.0	2.5	4.0^
9,000	(21')	5.5	5.0	4.5	4.0	5.0	4.5	4.0	5.5^	4.0	3.5	3.0	4.5^
12,000	(24')	6.0	5.5	5.0	4.5	5.5	5.0	4.5	4.0	4.5	4.0	3.5	5.0^
15,000		NR	6.0	5.5	5.0	6.0	5.5	5.0	4.5	5.0	4.5	4.0	3.5
20,000		NR	NR	6.0	5.5	NR	6.0	5.5	5.0	5.5	5.0	4.5	4.0
25,000		NR	NR	6.5	6.0	NR	6.5	6.0	5.5	6.0	5.5	5.0	4.5

^ - Bypass installation recommended. See "Installation Tips" on page 6. RECOMMENDED FLOW RATE: 20-60 gpm

NR - This pump size is not recommended for this size pool.

24 HOUR, LOW-SPEED PUMP-RUN TIME

In order to ensure proper performance when running the pump on low speed for 24 hours per day or high speed less than 6 hours per day, bleed the air while the pump is on by unscrewing the back knob until water appears. Then screw the knob back in. Repeat this process each time the cap is removed for any reason. Set the control dial at #6 and follow the adjustment directions in Step 2 to determine the correct setting for your pool.

EXAMPLE

POOL SIZE		12 HOUR PUMP RUN TIME			
Gallons	Diameter	PUMP SIZE			
		1/2 hp	3/4 hp	1 hp	1 1/2 hp
7,000	(18')	4.5	4.0	3.0	5.0^
9,000	(21')	5.0	4.5	4.0	5.5^
12,000	(24')	5.5	5.0	4.5	4.0
15,000		6.0	5.5	5.0	4.5
20,000		NR	6.0	5.5	5.0
25,000		NR	6.5	6.0	5.5

Find your starting dial setting by matching up the parameters of your pool on the above chart. A pool with approximately 12,000 gallons with a 1 horsepower pump running 12 hours a day would require a starting setting of 4.5.

2.



For the first week, test the pool water daily for free chlorine with FROG Test Strips to ensure correct dial setting. Continue to test weekly throughout the season.



After each testing, adjust the dial up by 1/2 increment if the free chlorine reading has dropped below 0.5 ppm or adjust down by 1/2 increment if the reading has risen above 1.0 ppm. Continue this process each day until the free chlorine reading stabilizes to at least 0.5 ppm.

IMPORTANT: Control dial settings in excess of these recommendations could result in excess trichlor levels being discharged into the pool. This can result in bleaching or discoloration of areas around the pool inlet or, in some cases, bleaching or discoloration of the entire pool liner or paint. In addition, excess trichlor in the pool can create health hazards to bathers.

Remember to adjust dial by 1/2 increments only in order to prevent over chlorination which may bleach pool surfaces.

Step 4: Routine Pool Care

1.



Run filtration enough hours to circulate all water 1 to 2 times per day. More than that could result in over chlorination.



WARNING

To prevent the build up of gas pressure in the FROG Leap Infuzer, be sure the pool return line valves are open except when opening or servicing the unit.

2.



Regularly test water with FROG Test Strips to maintain pH and Total Alkalinity.

NOTE: Water balance is affected by bather load, chemical usage, evaporation and the makeup of source water, so maintaining water balance regularly is important.

3.



Maintain 0.5 to 1.0 ppm free chlorine level at all times.

Note: These lower chlorine levels are only acceptable when using FROG minerals.



DANGER

Do not contaminate the FROG Leap Infuzer, FROG Leap Anti-Bac Mineral Pac, FROG Leap Torpedo Pac or FROG Leap Pool Wake Up!/Pool Hibernation (which includes FROG Leap Reveille, FROG Leap Depth Charge and FROG Leap All-Out) with dirt, organic matter, pool chemicals (such as calcium hypochlorite or pool shocks), fertilizers or other household chemicals. Contact between any of these substances and the FROG Leap Infuzer, FROG Leap Anti-Bac Mineral Pac, FROG Leap Torpedo Pac or FROG Leap Pool Wake Up!/Pool Hibernation, will result in a chemical reaction with the generation of heat, liberation of hazardous gasses and fire or explosion.

4.

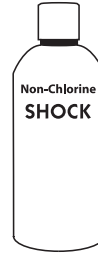

Shock the pool every other week or as needed. We recommend a non-chlorine shock as reducing chlorine use is the goal of FROG products. However, using a chlorine shock is OK too.



DANGER

- Never add any other types of chlorine, pH adjusters, shock treatments or algaecides through the skimmer. These products should be added directly into the pool if required.
- Never use fast dissolving chlorine tablets, liquid bleach, or calcium hypochlorite in the FROG Leap Infuzer.

5.



Before closing the pool for the winter, use FROG Leap Pool Hibernation following the same directions as FROG Leap Pool Wake Up! on page 17.

6.



Remember to replace FROG Leap Anti-Bac Mineral Pac and all other FROG Leap replacements as directed.

Replacing a FROG Leap Anti-Bac Mineral Pac

Must be replaced every 6 months or after one pool season.



1.



Check the FROG top of the box and back label of product to make sure you have the correct FROG Leap Anti-Bac Mineral Pac to fit your FROG Leap Infuzer.

IMPORTANT: The FROG Leap Anti-Bac Mineral Pac must be replaced every 6 months or after one pool season, whichever is shorter.

2.



IMPORTANT: Remove and read the information card.

Please note: Complete instructions for inserting a FROG Leap Anti-Bac Mineral Pac, and all other FROG Leap products are included inside the FROG Leap Anti-Bac Mineral Pac.



DANGER

- **Never use fast dissolving chlorine tablets, liquid bleach, or calcium hypochlorite in the FROG Leap Infuzer.**

3.

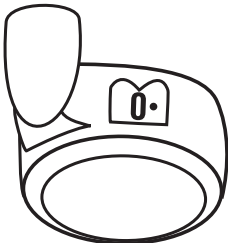

Turn off pump and turn dial to Setting 0. This reduces the flow of water into the unit when the cap is open.

4.



Open FROG Leap Infuzer cap.

5.

Remove the FROG Leap Torpedo Pac and if not empty, set to the side or store for winter. Then remove the FROG Leap Anti-Bac Mineral Pac and discard if it has been used for one pool season or 6 months, whichever is shorter.

6.

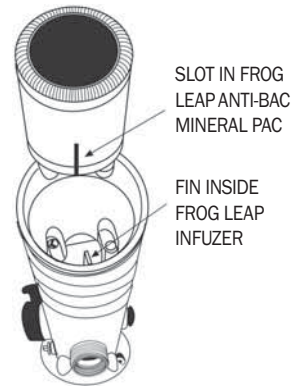

Find slot on side of FROG Leap Anti-Bac Mineral Pac and line up with fin inside the FROG Leap Infuzer. Lower FROG Leap Anti-Bac Mineral Pac into FROG Leap Infuzer until secure.

Replace the FROG Leap Torpedo Pac inside the FROG Leap Anti-Bac Mineral Pac to continue operating system (see directions on page 19).

7.



Mark your calendar ahead for the six month replacement of the FROG Leap Anti-Bac Mineral Pac. **Once wetted, the time-released mineral coating of this product is effective up to 6 consecutive months or one pool season, whichever is shorter. After that time you will hear the spent media inside, however, it is no longer effective and must be replaced.**

Using FROG Leap Pool Wake Up!



FROG Leap
Depth Charge



FROG Leap
Reveille



FROG Leap
All-Out

FROG Leap Depth Charge is a one time start-up product used to rid the water of all contaminants.

FROG Leap Reveille - also used at start up, sets the chlorine residual to help find the proper dial setting for maintaining up to 50%* less chlorine.

FROG Leap All-Out offers a 90-day Algae Protection Guarantee. *FROG Leap All-Out is also sold separately.*

For FROG Leap Depth Charge and Reveille



DANGER

Never use fast dissolving chlorine tablets, liquid bleach, or calcium hypochlorite in the FROG Leap Infuzer.



WARNING

Avoid sparks, smoking, or any open flame near FROG Leap Infuzer or chemicals.

Important: Read the labels on the FROG Leap Depth Charge, Reveille and All-Out products carefully before using.



1. Turn off pump. Turn control dial to 0. Open FROG Leap Infuzer cap. Stand back to let any chlorine fumes dissipate.

To remove colored caps, grab onto the lip of one cap with a pliers and pull up until cap releases. Repeat the process for the other cap.



2. Turn pac over and shake slightly until ingredients fall into tower areas.



3. Line up the small leg of the FROG Leap Depth Charge or Reveille with the small opening in the FROG Leap Anti-Bac Mineral Pac and the large leg with the large opening. Lower pac into FROG Leap Anti-Bac Mineral Pac until secure.

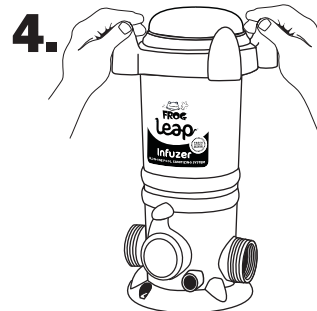
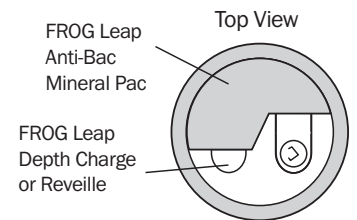

4. Replace cap by hand only. **DO NOT OVER TIGHTEN.**

5. Turn control dial on FROG Leap Infuzer to Setting 10.

6. Run the pump and filter for each pac according to the directions on the product label. Remove from the FROG Leap Infuzer when empty and discard in trash or offer for recycling if available.

Using FROG Leap All-Out for an Algae-Protection Guarantee

If you are not using FROG Leap All-Out refer to page 19 for Using the FROG Leap Torpedo Pac. See FROG Leap All-Out product labeling for complete directions for use (EPA Reg. No. 53735-9).

For a preventive dose add:

- One FROG Leap All-Out for pools up to 15,000 gallons.
- Two FROG Leap All-Out for pools between 15,000 & 30,000 gallons.

NOTE: If using directly after a shock treatment, test the water first to ensure the pH is in the proper range of 7.2-7.8 and the chlorine level is no more than 4.0 ppm. Avoid using other chemicals until this product has been circulated (filtered) for at least 24 hours.



DANGER

Never use fast dissolving chlorine tablets, liquid bleach, or calcium hypochlorite in the FROG Leap Infuzer.

Important: If storing FROG Leap All-Out prior to use, always keep in a cool, dry place away from children and pets.



Remove cap from FROG Leap All-Out without removing seal.

Turn off pump. Turn control dial to 0. Open FROG Leap Infuzer cap. Stand back to let any chlorine fumes dissipate.



Insert upside down into center of FROG Leap Anti-Bac Mineral Pac pushing down firmly on FROG Leap All-Out bottle allowing key in FROG Leap Infuzer to puncture seal.

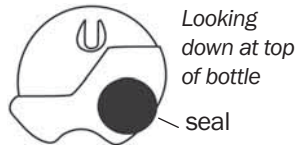

Replace cap by hand only. **DO NOT OVER TIGHTEN.**

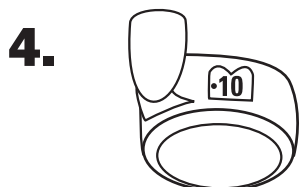

Turn control dial on FROG Leap Infuzer to Setting 10.



Turn pump on for 90 minutes allowing FROG Leap All-Out to circulate through pool.

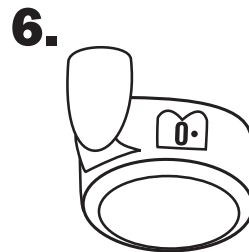

To remove expended FROG Leap All-Out bottle, turn pump off and turn dial to Setting 0.



Remove FROG Leap Infuzer cap.



Lift FROG Leap All-Out up and allow any water in the container to drain through the FROG Leap Infuzer before discarding in trash or offering for recycling. Do not reuse or refill this container.

NOTE: If water shows more than a hint of blue inside FROG Leap Infuzer, replace the FROG Leap Infuzer cap, turn dial to Setting 10 and run the pump for one minute.

8a. If pool size requires additional FROG Leap All-Out, repeat steps 1-8.

8b. When water is clear in FROG Leap Infuzer, insert a FROG Leap Torpedo Pac according to the instructions on page 19.

Using FROG Leap Torpedo Pac



FROG Leap Torpedo Pac is required to assure up to 50% reduction in chlorine use*. FROG Leap Torpedo Pac sold separately. (EPA Reg. No. 53735-2)



DANGER

Never use fast dissolving chlorine tablets, liquid bleach, or calcium hypochlorite in the FROG Leap Infuzer.



WARNING

Avoid sparks, smoking, or any open flame near FROG Leap Infuzer or chemicals.

IMPORTANT: Read the label on the FROG Leap Torpedo Pac carefully before using.

1.



Turn off pump. Turn control dial to 0. Remove cap from FROG Leap Infuzer and stand back to let any chlorine fumes dissipate.

2.



Colored Caps

Remove colored caps by grabbing on the lip of one cap with a pliers and pulling up until cap releases. Repeat the process for the other cap.



PAC TOWERS — PAC TOWERS

FROG Leap Torpedo Pac and slightly until chlorine tablets fall over areas.

4.



Line up small leg of the FROG Leap Torpedo Pac with small opening in FROG Leap Anti-Bac Mineral Pac, and large leg with large opening. Lower FROG Leap Torpedo Pac into FROG Leap Anti-Bac Mineral Pac until secure.

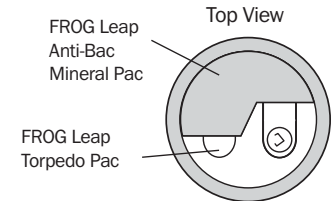

5.



Replace cap by hand only. **DO NOT OVER TIGHTEN.**

6.



The chlorine pac container is made of HDPE plastic. Non-refillable container. Do not reuse or refill this container. Rinse thoroughly before discarding in trash or offering for recycling if available.

7.



Mark your calendar ahead for the approximate replacement times for the FROG Leap Torpedo Pac.

Winterizing

1.



Before closing your pool, refer to page 17 and follow directions for using FROG Leap Pool Hibernation (same directions as using FROG Leap Pool Wake Up!). Then proceed to steps 2-7 below.

2.

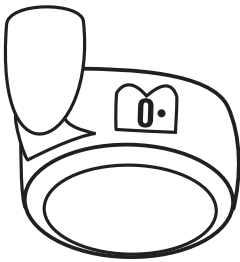

Turn pump off and turn dial to Setting 0.

3.



Remove cap.

4.

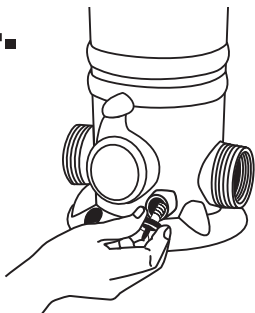

Unscrew knob from the front of FROG Leap Infuzer. Allow all water to drain.

5.



If FROG Leap Torpedo Pac still contains chlorine, wrap in plastic bag and store in shed or cool, dry, well-ventilated location away from children, pets, cars, motorcycles or anything metal that can rust, pit, etc.

If empty, rinse and recycle.



WARNING

Avoid sparks, smoking, or any open flame near FROG Leap Infuzer or chemicals.

6.



Remove the FROG Leap Anti-Bac Mineral Pac and discard in trash. You will hear spent media inside, however, it is no longer effective.

7.



Replace the cap and knob loosely.

Troubleshooting

For more in-depth troubleshooting, go to frogproducts.com or call King Technology at 800-222-0169.

Problem	Remedy		
<p>1. What do I do if the water looks cloudy?</p>	<p>1. Make sure your filtration system is working properly (i.e. clean filter, skimmer and pump basket).</p> <p>2. Make sure circulation time is adequate – increase pump</p>	<p>time if not.</p> <p>3. Make sure the pool is properly balanced. (See page 11.)</p> <p>4. Shock the water to eliminate build up of any organic matter.</p>	<p>5. Make sure pool has a free chlorine reading of 0.5 to 1.0 ppm.</p> <p>6. Check with your dealer for more information.</p>
<p>2. What do I do if the water turns color?</p>	<p>1. Algae may be trying to form – shock the pool, increase circulation time if needed and clean the filter.</p>	<p>2. Metals in the fill water may have been oxidized. Have the pool tested. See pool dealer if a metal control product is required.</p>	<p>3. Check with your dealer for more information.</p>
<p>3. What do I do if algae forms in or on my pool?</p>	<p>1. Use FROG Leap All-Out or an effective algaecide per the directions on the bottle and brush the sides of the pool often.</p> <p>2. Clean the filter and shock the pool with chlorine daily until</p>	<p>water clarity returns.</p> <p>3. If you are in an area of the country that struggles with algae growth, see your dealer regarding a 90-day Algae-Protection Guarantee</p>	<p>using FROG Leap All-Out. See product hang tag for guarantee details.</p> <p>4. Check with your dealer for more information.</p>
<p>4. What do I do if I am under chlorinating with the FROG Leap Torpedo Pac?</p>	<p>1. If you are unable to maintain 0.5 to 1.0 ppm, first make sure there are chlorine tablets in the tower areas of the FROG Leap Torpedo Pac and it is installed properly. If a correction was made, test the water in 24 hours.</p> <p>2. If still low, turn the dial up one setting and test the water again in 24 hours. Continue raising the setting by one increment each day until the</p>	<p>proper reading is achieved.</p> <p>3. Shock the pool if the reading has been lower than 0.5 ppm for more than one day.</p> <p>4. Make sure pump run time is at least 6 hours on high speed (40 gpm or higher) or if not, bleed the air from the back knob each time cap is open.</p> <p>5. Contact your dealer to have your back pressure tested. If under 4 psi, consider a smaller</p>	<p>eyeball fitting in the return jet.</p> <p>6. Check for a suction side leak by looking for air bubbles in your pump basket or at the return jet. Contact dealer for help in correcting this situation.</p> <p>7. Contact King Technology's Customer Service Department at 800-222-0169.</p>
<p>5. What do I do if I am over chlorinating with the FROG Leap Torpedo Pac?</p>	<p>1. If the chlorine reading is over 3.0 ppm, remove the FROG Leap Torpedo Pac from the FROG Leap Anti-Bac Mineral Pac and test the water daily until the reading is down to 1.0 ppm.</p> <p>2. Reinsert the FROG Leap Torpedo Pac, lower the dial one setting and test the water again in 24 hours. If the reading has risen, lower the dial one setting again. Continue this process until</p>	<p>proper reading is achieved.</p> <p>3. If over-chlorinating at the lowest possible setting, consider decreasing the circulation time. Depending on your pump size, you may be circulating the water more than is necessary.</p> <p>4. Contact your dealer to have your back pressure tested. If over 8 psi consider a larger eyeball fitting in the return jet.</p>	<p>5. Check to see if the pressure relief valve is loose or missing and replace. It is a clear plastic piece approximately 1" long installed inside near the base. If loose or missing, it can provide another avenue for water to reach the chlorine.</p> <p>6. Contact King Technology's Customer Service Department at 800-222-0169.</p>

Parts List Model 7800

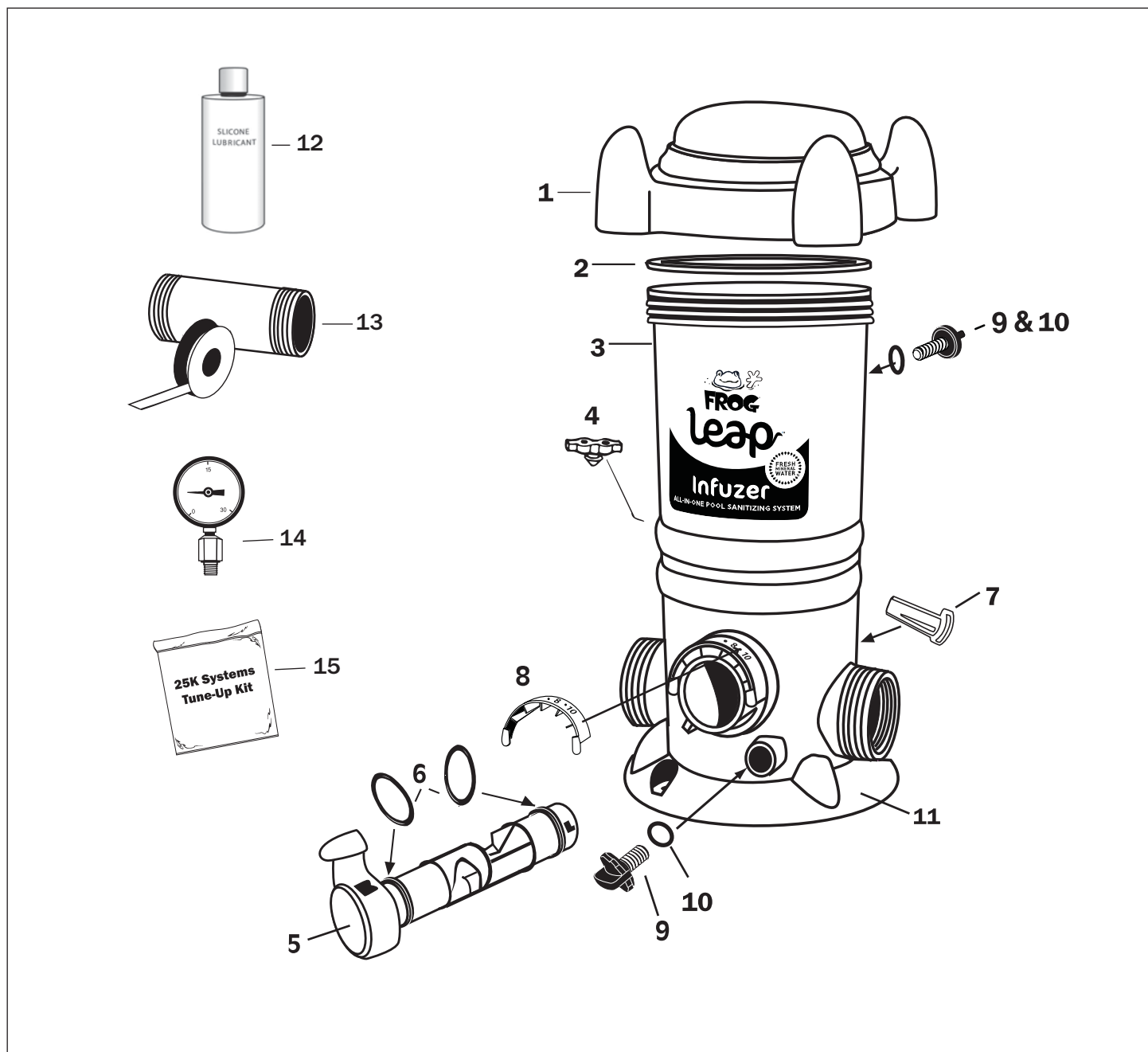

Included with FROG Leap Infuzer 7800

REF. #	DESCRIPTION	QTY. INCLUDED
1 & 2	Cap w/O-Ring	1
3	Body	1
4	Pressure Relief Valve	1
5, 6, 7, 8	Control Dial with O-Rings, Locking Pin and Number Plate	1
9 & 10	Knob with O-Ring	2
11	Mounting Base	1
12	Silicone Lubricant	1
13	Nipple Kit	1

Replacement parts for FROG Leap Infuzer 7800

REF. #	PART NO.	DESCRIPTION
1 & 2	01-22-1426	Cap w/O-Ring
2	01-22-1922	Cap O-Ring
4	01-22-9485	Pressure Relief Valve
5, 6, 7, 8	01-22-1457	Control Dial with O-Rings, Locking Pin and Number Plate
6	01-22-1456	Control Dial O-Ring Set
9 & 10	01-22-9625	Knob with O-Ring
11	01-22-1481	Mounting Base
12	01-22-9972	Silicone Lubricant 3/4 oz.
13	01-22-1711	Nipple Kit
14	01-22-4000	Pressure Gauge
15	01-22-1470	25k Tune-Up Kit

FROG Leap Infuzer Maintenance

Replacing the Control Dial O-Rings

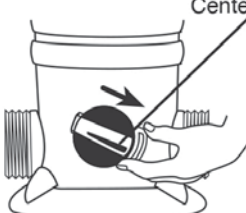
1.  Center of locking pin
In the back of the FROG Leap Infuzer, depress center of locking pin with a finger and pull pin out of dial.

2.  Turn control dial back and forth as you pull it out of the housing.

3.  Replace both O-rings. Apply silicone lubricant that came with your FROG Leap Infuzer on O-rings.
Part No. 01-22-9972

4.  Carefully insert control dial back into housing.

5.  Replace locking pin by pushing it through the slots on the dial until it locks into place.

Replacing the Cap O-Ring

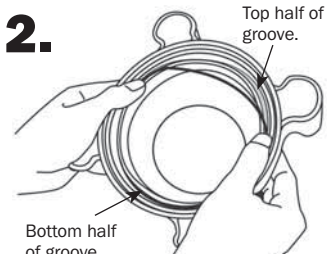
1. Remove old O-ring.
2.  Top half of groove.
Bottom half of groove.
Place new O-ring in bottom half of groove.

3.  Place your thumbs on each side of the cap over the O-ring in the groove.

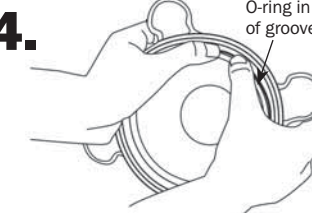
4.  O-ring in top of groove
Roll your thumbs back and forth over the O-ring while pushing upward until the O-ring falls into the top of the groove.

5.  Silicone Lubricant
Lubricate O-ring every couple of months with silicone lubricant that came with your FROG Leap Infuzer. DO NOT USE petroleum based lubricants.
Part No. 01-22-9972

Replacing Knobs

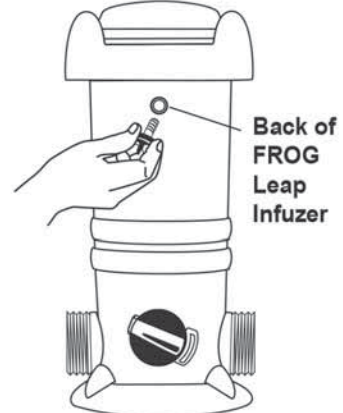
 Front of FROG Leap Infuzer
 Back of FROG Leap Infuzer
To replace, simply unscrew old knob and replace with the new one.

FROG Leap Infuzer Two-Year Limited Warranty

Register your product online today to extend your FROG Leap warranty to lifetime coverage.
frogproducts.com/reg

King Technology, Inc. will warrant this unit with a complete replacement for the original purchaser, should it prove defective by reason of improper workmanship and/or material for a period of two (2) years from the date of original purchase/installation. This warranty covers body, cap and control dial excluding O-rings. King Technology holds the option of replacing any defective part without charge if it is determined to be all that is needed to correct any situation. Parts used for replacement, with the exception of O-rings, are warranted for the remainder of the original warranty.

1. To obtain warranty service, you must deliver product to King Technology or its nearest authorized dealer. Shipping expenses are the purchaser's responsibility. The name of the nearest authorized dealer can be obtained at frogproducts.com/find-a-dealer or by calling King Technology at 1-800-222-0169. Proof of purchase is required when requesting warranty service. Purchaser must present the sales receipt or other document which establishes proof of purchase.

2. This warranty does not cover defects caused by: modification, alteration, repair or service of the product contrary to the accompanying instructions; physical abuse to or misuse of the product or operation or installation in a manner contrary to the accompanying instructions. This warranty also excludes all costs arising from the installation, adjustment, removal or replacement of defective units or parts. This warranty also excludes any and all claims arising out of the chemicals used in the product or their characteristics.

3. Any express warranty not provided for herein, and any remedy for breach of warranty or breach of contract which, but for this provision, might arise by implication or operation of law, is hereby expressly excluded and disclaimed. The implied warranties of merchantability and of fitness for any particular purpose are expressly limited to a term of two years. Some states do not allow limitation on how long an implied warranty lasts, so the above limitation may not apply to you.

4. Under no circumstance shall King Technology be liable to purchaser or any other person for any damage or loss incurred because of any chemicals used in the product or their physical characteristics, or interruption of service of the product, or any special, incidental or consequential damages or losses, whether arising out of breach of warranty, breach of contract or otherwise. Some states do not allow the exclusion or limitation of incidental consequential damages, so the above limitation or exclusion may not apply to you.

5. Misuse or failure to use the proper FROG Leap Anti-Bac Mineral Pac, FROG Leap Torpedo Pac or FROG Leap Pool Wake Up!/Pool Hibernation (which includes FROG Leap Depth Charge, FROG Leap Reveille and FROG Leap All-Out) may cause damage to equipment or personal injury. All warranty null and void if this product is not used with the recommended FROG Leap Anti-Bac Mineral Pac, FROG Leap Torpedo Pac or FROG Leap Pool Wake Up!/Pool Hibernation.

Don't forget to register your warranty and sign up to receive emails on special offers and helpful water care tips. Visit frogproducts.com/reg

MANUFACTURED BY



© King Technology, Inc. The following are trademarks of King Technology, Inc.

FROG®
FROG Leap®
FROG Leap Anti-Bac Mineral Pac®

FROG Leap Torpedo Pac®
FROG Leap Pool Wake Up!/Pool Hibernation®
Fresh Mineral Water®∞

530 11TH AVE S, HOPKINS, MN 55343 | 800.222.0169 | frogproducts.com